

P210

The Legendary Swiss Sports Pistol



SWISS+
ARMS

SWISS+
ARMS



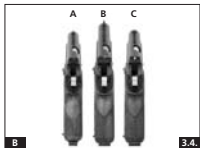
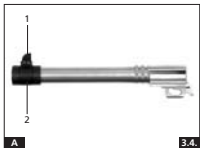
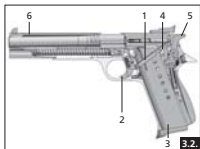

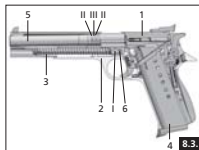
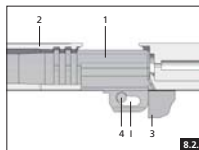
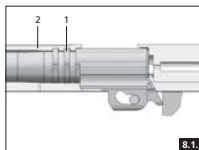
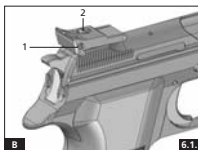

P 210-5LS, sectional view

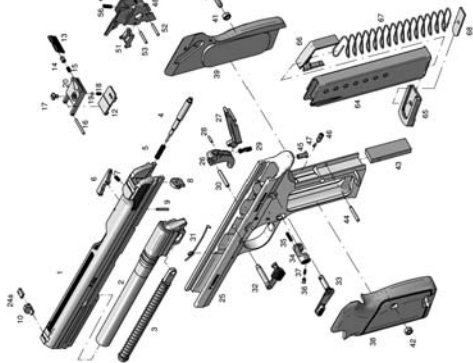

Contents

1.	General instructions	2
2.	Safety regulations	3
3.	Product description	4
3.1.	General description of the firearm	4
3.2.	Main features	4
3.3.	Various models	6
3.4.	Options	6
3.5.	Technical data	7
3.6.	Scope of supply	8
4.	Transporting the firearm	8
5.	Handling the firearm	9
5.1.	General remarks	9
5.2.	Initial preparation	9
5.3.	Ammunition	9
5.4.	Loading the magazine	9
5.5.	Loading the firearm (ready to fire)	9
5.6.	Discharging a shot	10
5.7.	Reloading during shooting	10
5.8.	Unloading the firearm	11
5.8.1.	Unloading the firearm, magazine not emptied	11
5.8.2.	Unloading the firearm, magazine emptied, slide open	11
6.	Adjusting Sight	12
6.1.	Correcting the sights	12
7.	Maintaining the firearm	13
7.1.	Stripping the firearm	13
7.2.	Removing the front sight base	13
7.3.	Maintenance	13
8.	Description of the functions	14
9.	Service and repairs	14
9.1.	Safekeeping and storage of firearm	14
9.2.	Shipping the firearm	14
10.	Accessories	15
11.	Disposal	15
12.	Spare parts	16

1. General Instructions

Be sure to read through these instructions carefully before attempting any handling on this Swiss Arms firearm.

Understanding these instructions and the technically correct implementation of the information contained therein are **imperative** to correct initial preparation and safety during handling, care and maintenance of this Swiss Arms firearm. Only first use the firearm when you have fully understood all the safety instructions and the handling of the firearm. Should you require further information, do not hesitate to contact your dealer, importer or the manufacturer.

Ensure that you always comply with the local and national laws that govern ownership, carrying and use of firearms.

Be aware that this firearm, like all firearms, is dangerous. The firearm to which these safety instructions apply was sold under the expressed condition that the manufacturer and the importer of the firearm do not accept any liability for the consequences of mishandling or incorrect use of the firearm. This applies in particular to liability for bodily harm or damage to property resulting in whole or in part from:

- discharge with criminal intent or through negligence,
- improper or careless handling,
- defective, incorrect, hand-loaded or reloaded ammunition,
- inadequate care of the firearm (e.g. corrosion, damage),
- disregard of malfunctions,
- resale in contradiction of regional laws and legislation,
- other circumstances beyond our direct or immediate control.

These limitations apply, regardless of whether liability is asserted on the basis of a contract, negligence or strict liability (including any failure to warn).

Neither do the manufacturers or the importers bear any liability for incidental or consequential damages such as loss of use or property, commercial losses or loss of earnings and profits.

2. Safety regulations

- ▲ Never use this firearm when under the influence of alcohol or drugs, during illness or other complaints; they can influence your judgement and reflexes.
- ▲ Always consider the firearm as loaded and unsafe until you have performed the unloading procedure to verify that it is not (see Sect. 5.8.).
- ▲ During all manipulations, keep the muzzle of the firearm pointed in a safe direction. Safe directions are defined as areas where there are no people, other living creatures or other people's property.
- ▲ Never point the firearm at doors, window panes, walls, concrete, stones or other flat surfaces (including water). Shots can penetrate such surfaces, or be deflected into unsafe directions by them.
- ▲ Never aim at yourself or other human beings.
- ▲ Never rely on safety mechanisms. They can never be a substitute for careful and correct handling of this firearm.
- ▲ Always handle your firearm as if the safety mechanisms were defective. The best safety device is the correct, frequently practised and secure handling of this firearm.
- ▲ Never fire a firearm which has been penetrated by water, sand, dirt or other foreign bodies.
- ▲ Never decock the hammer by holding on to the hammer and pulling the trigger at the same time.
- ▲ Never let a loaded rifle out of your hands.
- ▲ Always unload the firearm immediately after firing, before putting the firearm away, putting it into a holster or handing it to another authorized person.
- ▲ Never hand over this firearm to another person without these Handling and Safety Instructions.
- ▲ Never leave this rifle unattended. Unauthorised persons could use it to cause damage, threaten or kill other people, for which you could be held liable.
- ▲ Never put away the firearm loaded. Remove the magazine and verify that there is no round in the chamber by performing the unloading procedure (see Sect. 5.8.).
- ▲ Always keep the firearm and the ammunition stored in different places, and ensure that neither can fall into the hands of unauthorised persons or children.

The following safety advice highlights the different dangers in the individual sections of these instructions:



Information on risks which, if not scrupulously observed, can directly lead to grievous bodily harm or death.

3. Product description

3.1. General description of the firearm

The firearm P 210 which incorporates many years of experience in the design and manufacture of firearms, is a top-quality handgun.

Because of its versatile optional equipment, the P 210 is a firearm that meets all requirements of a marksman.

The firearm P 210 is a mechanically locked recoil operated firearm that is reloaded automatically after each shot. After the last shot has been fired the slide is retained in the open position.

All models are caliber 9 mm Para (9 mm x 19) and are fitted with the reinforced grip.

3.2. Main features

Incomparable accuracy

- through long guide grooves on the slide and the frame;
- through positive locking between barrel and slide;
- through favorable placement of the center of gravity;
- through outstanding trigger characteristic;
- because of a control cam that ensures that opening of the action does not occur until the projectile leaves the barrel.

Simple maintenance

- because disassembly is easy and requires no tools;
- because the closed design largely protects the firearm from contamination.

3. Product description

Reliable safety

In the “S” position the **safety lever** blocks the trigger bar (1) and the trigger (2) connected to it (Fig. 3.2.).

As a **safety feature in the case of incomplete locking**, the slide (6) pushes the trigger bar (1) down for as long as the former is not in the forward limit position. The trigger action is thus interrupted.

The hammer (5) features a second notch as a **safety catch**. Should the hammer slip during manual cocking before it is fully cocked, it will be stopped by the safety notch.

For models P 210-5 and P 210-6:

The **magazine safety** pushes the trigger bar (1) down when the magazine (3) is removed. As a result the trigger bar is disconnected from the sear (4) and the hammer (5) cannot be released.



In the case of the P 210-5 LS and P 210-6S models with side magazine catch, the magazine safety is not provided, which means that the trigger can be activated without a magazine being inserted.

3. Product description

3.3. Various models

A P 210-6

The standard firearm with sand blasted surface and target trigger.

B P 210-6S

Same model with micrometer sight, side magazine catch and reinforced magazine floorplate.

C P 210-5

The high precision sports firearm with extended barrel, micrometer sight, long line of sight and target trigger.

D P 210-5LS

An extremely accurate sports firearm with long slide, micrometer sight, long line of sight, target trigger, side magazine catch and reinforced magazine floorplate.

3.4. Options

Extended barrel

A

150 mm (caliber 9 mm parabellum).

The extended barrel features the front sight (1) on a base (2). The line of sight is thereby extended and the accuracy in manual firing is increased.

We recommend to close the front sight groove with the special cover piece.

Shooting with the extended barrel is only possible in conjunction with micrometer sights.

Sights

B

- Standard sights (A)
- Contrast sights (B)
- Micrometer sights (C)

The line of sight is extended by 12 mm in conjunction with micrometer sights.

Front sights of various sizes are available for all types of sighting.

3. Product description

3.5. Technical data

Model	P 210-6	P 210-6S	P 210-5	P 210-5LS
Caliber	9 mm Para	9 mm Para	9 mm Para	9 mm Para
Overall length	215 mm	215 mm	245 mm	245 mm
Barrel length	120 mm	120 mm	150 mm	150 mm
Rifling length	250 mm	250 mm	250 mm	250 mm
Number of grooves	6	6	6	6
Weight without magazine	925 g	940 g	945 g	1010 g
Magazine weight, empty	85 g	110 g	85 g	110 g
Trigger pull weight approx.	1.5 Kg (15 N)	1.5 Kg (15 N)	1.5 Kg (15 N)	1.5 Kg (15 N)
Trigger travel	1.8 - 2.0 mm	1.8 - 2.0 mm	1.8 - 2.0 mm	1.8 - 2.0 mm
Magazine capacity	8	8	8	8
Muzzle energy* (joules)	470 J	470 J	490 J	490 J
Sight base	164 mm	176 mm	200 mm	204 mm

* Depends on ammunition make.

3. Product description

3.6. Scope of supply (Fig. 3.6.)

- Pistol
- Case
- Magazine filler
- Operating instructions
- Hook wrench (P 210-5 model)

Not included with delivery:

- Cleaning materials
- Spare magazine
- Sight shifter

4. Transporting the firearm



- ▲ For your own safety and the safety of others, always transport the firearm **unloaded** (see Section 5.8.), **decocked and closed**.
- ▲ Never carry the firearm on your person with a round in the chamber and the hammer cocked.
- ▲ Always carry the firearm in such a manner that, should you fall or otherwise slip, you are able to control the direction of the muzzle.
- ▲ Transport the firearm separate from the ammunition.
- ▲ Ensure that you comply with all regional and national laws governing the transport of firearms.

5. Handling the firearm

5.1. General remarks

The firearm is delivered with a light, protective and preserving coating of oil and it must be stripped before initial preparation, the protective coating of oil removed, and the firearm must be relubricated.

5.2. Initial preparation

Procedure

1. Stripping the firearm (Fig. 7.1.)
2. Clean and relubricate the firearm (Fig. 7.3.)
3. Assemble the firearm (Fig. 7.1.).

5.3. Ammunition



- ▲ Only use ammunition available from specialist dealers in its original packing for your firearm, this being ammunition that corresponds with the caliber of the firearm. The correct caliber is imprinted on the firearm.
- ▲ Never use reloaded, „refurbished“, handloaded, non-standard ammunition, or ammunition of a different caliber.
- ▲ Never use dirty, wet, corroded, bent, damaged or oiled ammunition.
- ▲ Never leave ammunition unattended.

5.4. Loading the magazine

Procedure

1. Place the round on feeder 66, close to the magazine lips.
2. Thumb down the round and slip it to the rear.
3. Load as many rounds as you intend to shoot.

The number of loaded rounds can be checked through the holes on the magazine.

5.5. Loading the firearm (ready to fire)



- ▲ Never load or unload the firearm inside a vehicle, inside a building or other confined space (except in a designated firing range).
- ▲ Always wipe off any excess grease and oil before loading and check to see if there are any foreign objects/material in the barrel (2).
- ▲ Always keep the muzzle of the firearm pointed in a safe direction.
- ▲ Do not place your finger on trigger 26, but keep it outside of the trigger guard.
- ▲ Do not load the firearm by inserting magazine until immediately before shooting.
- ▲ Never directly draw back hammer 50 by hand in order to cock it.
- ▲ Never rely on the safety mechanisms alone. These are no substitute for careful and correct handling of the firearm.
- ▲ Never leave a loaded firearm out of your hand.

Procedure

1. Point the firearm in a safe direction.
2. Insert a full magazine 64 and check that it engages.
3. Draw slide 1 back until stop and allow to flick forward.
 - The firearm is loaded and ready for firing with the single action trigger.

5. Handling the firearm

5.6. Discharging a shot



- ▲ Ensure that the target and surroundings allow for danger-free firing.
- ▲ Be certain when firing that your fingers, hands or other parts of the body are not in front of, above or beside the barrel muzzle or the ejector port.
- ▲ Never allow a third person to stand next to you where they could be hit by ejected cartridge cases (danger of burn injury).
- ▲ When shooting, always wear ear protection and protective eyeglasses. Inform other people close to you about the need to wear ear protection.
- ▲ Interrupt shooting immediately and unload the firearm (see Section 5.8) if you suspect that a round is not inserted correctly, a case is jammed, a round may have blocked the barrel or a shot sounds or gives the sensation that it may be “weak” or unusual.
- ▲ Never try to dislodge a blockage by firing another round.

Procedure

1. Aim the firearm at a safe target.
2. Place your finger on trigger and pull back trigger to discharge the shot.
3. Keep the firearm aimed at the target and fire further shots as required.
4. Remove the magazine and unload firearm (Fig. 5.8.). If the firearm has been shot until the magazine is empty, the slide will remain in the open position. Reload the firearm if further shots are to be fired (Fig. 5.7.).



- ▲ The firearm is in a cocked and ready to fire status after each discharge.

5.7. Reloading during shooting

The slide is caught in the open position.



- ▲ Never leave the firearm out of your hand.
- ▲ Keep the firearm pointed at the safe target.

Procedure

1. Remove empty magazine.
 2. Insert full magazine and ensure that it is fully engaged.
 3. Thumb down slide catch lever (32) or draw back slide (1) until stop and allow to flick forward (see Section 5.5.).
- The firearm is loaded and ready for firing.

5. Handling the firearm

5.8. Unloading the firearm

5.8.1. Unloading the firearm, magazine not emptied



- ▲ Never leave the firearm out of your hand before it is unloaded.
- ▲ The firearm is loaded; a round is in the chamber of the barrel.
- ▲ In the case of the P 210 5LS and P 210 6S models with side magazine catch, the magazine safety is not provided, which means that the trigger can be activated without a magazine being inserted.

Procedure

1. Keep the muzzle pointed in a safe direction.
2. Press magazine catch (34 or 63) and remove magazine (Fig. 5.8.1.).
3. Pull slide (1) back until stop and push slide catch lever (32) up. The round is ejected and the slide (1) is caught in the open position.
4. Check that the round has been ejected and that no other round is chambered (Fig. 5.8.2.).
5. Actuate slide catch lever (32). The slide (1) flicks forward.
6. Releasing – Safety lever (33) on “F”.
7. Pull trigger (26) while aiming at target.
8. Safety on – Safety lever (33) to “S”.
9. Empty magazine (64).
10. Pick up ejected rounds and clean it.

The firearm is unloaded and decocked.
The firearm must be cleaned after each shooting session (Fig. 7.).

5.8.2. Unloading the firearm, magazine emptied, slide open

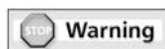

- ▲ The firearm must not be left out of your hand until the magazine has been removed and the firearm is unloaded.
- ▲ In the case of the P 210 5LS and P 210 6S models with side magazine catch, the magazine safety is not provided, which means that the trigger can be activated without a magazine being inserted.

Procedure

1. Keep the muzzle pointed in a safe direction.
 2. Press magazine catch (34 or 63) and remove magazine.
 3. Check that there is no round in the chamber (Fig. 5.8.2.).
 4. Actuate slide catch lever (32).
The slide (1) flicks forward.
 5. Releasing – Safety lever (33) on “F”.
 6. Pull trigger (26) while aiming at target.
 7. Safety on – Safety lever (33) to “S”.
- The firearm is unloaded and decocked.

6. Adjusting Sight

6.1. Correcting the sights

Standard and contrast sights:

Sighting is corrected by shifting the front sight laterally and by installing front sights of various sizes. Corrections should only be made with a front sight pusher. (Fig. 6.1. A)

If the impact points is:

- too far left: shift front sight to the left
- too far right: shift front sight to the right
- too high: install larger front sight
- too low: install smaller front sight

Normal and contrast front sights are available in 8 different sizes as set out in the table below.

Number	Height (mm)	Shown as
04	5.1	(-...)
03	5.3	(-..)
02	5.5	(- .)
01	5.7	(-)
00	5.9	(N)
05	6.1	(+)
06	6.3	(+ .)
07	6.5	(+..)

Moving the front sight to the side by 0.1 mm corresponds with a shifted impact point of 3 cm over a distance of 50 m.

Changing the front sight by one size shifts the height of the impact point by 6 cm over a distance of 50 m.

Micrometer sights:

Coarse adjustment same as for standard or contrast sights.

Front sights for micrometer sights are available in 4 different sizes: 7.5/8/8.5/9 mm.

Changing the front sight by one size shifts the height of the impact point by 15 cm over a distance of 50 m.

Fine-adjustment: (Fig. 6.1. B)

If the impact point is

- too far left: turn windage screw (1) counterclockwise (toward rear)
- too far right: turn windage screw (1) clockwise (toward front)
- too high: turn elevation screw (2) clockwise
- too low: turn elevation screw (2) counter clockwise

Top screw (2)

1 turn until engaging point shifts the rear sight by 0.07 mm.

Side screw (1)

1 turn until engaging point shifts the rear sight by 0.09 mm.

This shifts the impact point at 50 m as follows:

Model	Height	Side
P 210-6S	2 cm	2.5 cm
P 210-5	2 cm	2 cm
P 210-5LS	2 cm	2 cm

7. Maintaining the firearm

7.1. Stripping the firearm

1. Unload the firearm (Fig. 5.8.1.).
2. Remove the magazine.

A

Grip frame and slide with your right hand. Pull slide backward approximately 5 mm while at the same time pushing down on the slide stop from the right with your left-hand index finger until it moves to the left and can be removed.

B

Pull off the slide with barrel and recoil spring toward the front.

C

Grip rear of recoil spring and pull it out.

D

Lift the barrel a little at the rear end, push forward slightly and remove to the rear.

The extended barrel with front sight base can only be removed from the slide after the front sight base has been dismantled (Fig. 7.2.).

This disassembly operation suffices for thoroughly cleaning the P 210 (Fig. 7.1. E).

More detailed disassembly work should only be performed by trained specialists.

The firearm is reassembled by performing the disassembly steps in the reverse order.

7.2. Removing the front sight base

- ▲ Unfasten the front round nut with the aid of the hook spanner and unscrew it from the barrel.
- ▲ Pull the first shim off the barrel.
- ▲ Pull the front sight base off the barrel.
- ▲ Remove key from the groove.
- ▲ Pull off second shim.
- ▲ Unscrew rear round nut.

To reassemble, perform the dismantling steps in the reverse order. Ensure that the tapered end of the key points downward when you reinsert it into the groove on the barrel.

7.3. Maintenance

By observing the following maintenance instructions you ensure that the firearm P 210 will remain in excellent condition even after years of hard duty.

Barrel and chamber

- ▲ Clean the bore and the chamber with firearm oil after each shooting exercise. Use a suitable cleaning rod of the right caliber.

Important:

Never clean the barrel from the front. Never use a steel brush because the latter could damage the smooth surface of the bore.

- ▲ Lightly treat barrel bore, chamber and moving parts with firearm oil.

External metallic surfaces

- ▲ After each shooting exercise wipe all external metallic surfaces with a piece of cloth soaked with firearm oil.

8. Description of the functions

8.1.

At the instant a shot is fired the firearm is locked. The locking ribs of the barrel (1) engage in the locking grooves of the slide (2). The barrel is retained in its position by the slide stop.

8.2.

The pressure of the powder gas drives the projectile out of the barrel (1) and at the same time pushes back the slide (2) as well as the barrel (1). After a recoil motion of approximately 3 mm the barrel (1) is lowered by the slide stop (4) which slides in the control cam (I). It separates from the slide (2) and rests against the frame (3). The firearm is unlocked.

8.3.

The slide (1) continues its recoil motion until it contacts the frame (2). During the recoil of the slide (1) the extractor ejects the empty cartridge from the chamber. The cartridge hits the ejector nose and is ejected. The tensioned recoil spring (3) pulls the slide (1) forward again. During this movement the next cartridge is fed from the magazine (4) into the chamber. The last part of the forward movement of the slide (1) coincides with the movement of the barrel (5), and the control cam (I) in conjunction with the slide stop (6) pivots the barrel (5) upward. The locking ribs (II) of the barrel (5) engage in the locking grooves (III) of the slide (1). The firearm is now locked and ready to be fired.

9. Service and repairs

9.1. Safekeeping and storage of firearm



- ▲ Always store your firearm in the unloaded and cleaned condition.
- ▲ Always keep the firearm separate from the ammunition and locked up. The firearm and ammunition must not be accessible to children, people who are not experienced in the handling of firearms, or other unauthorised persons.

9.2. Shipping the firearm



- ▲ Familiarise yourself fully with local legislation governing the shipping and transportation of firearms.
1. Check firearm to ensure it is unloaded and decocked.
 2. Pack the firearm well (if possible in its original packaging) to prevent damage in transit. To prevent the firearm from being recognized as such during shipping, wrap the original packaging in a second outer layer. No other accessories should be packed with the firearm.

10. Accessories

3. Enclose a letter stating the following:
 - Your full name,
 - your full address (mention street, not P.O. box),
 - your daytime telephone number,
 - model and serial number of the firearm,
 - detailed description of the problem encountered or work to be performed.
- Spare magazine
 - Cleaning materials
 - Sight shifter
 - Micrometer sight
 - Normal sight
 - Contrast sight
 - Magazine filler

4. Send the firearm insured and carriage paid (parcels with incorrect postage will not be accepted) to:

1. The point of sale where the firearm was purchased
2. To the Swiss Arms representative (importer) in your country
3. If a local Swiss Arms specialist dealer or a Swiss Arms representative is not available in your country, send to the following address:

SAN Swiss Arms AG
Industrieplatz
CH-8212 Neuhausen am Rheinfall

11. Disposal

- Always comply with the existing national laws on the disposal of handguns.
- Provided this does not contradict the above-mentioned laws, the firearm shall be sent to the address provided under Section 9.2, no. 4 for disposal.
- The specifications of Section 9.2 no. 3 must be observed when shipping the firearm.

12. Spare parts

Required information for ordering replacement parts:

- Firearm model
- Firearm number
- Caliber
- Item number
- Name/designation of individual part

Item	Designation	Item	Designation	Item	Designation
Slide					
1	Locking piece, LS	24a	Cover for front sight slot	51	Pressure lever
1a	Slide	10	Front sight for micrometer sights	52	Pressure lever pin
2	Barrel, 150 mm	Grip			
2a	Barrel, 150 mm with rifling	25	Grip for magazine catch, side	53	Trigger bar pin
2b	Barrel, 120 mm	25a	Grip for magazine catch, below	54	Hammer pin
3	Recoil spring	26	Trigger	55	Mainspring pin
4	Firing pin	27	Trigger guide	56	Trigger bar spring
5	Firing pin spring	28	Trigger guide pin	57	Mainspring bar
6	Extractor	29	Trigger spring	58	Mainspring
7	Extractor spring	30	Trigger pin	59	Mainspring head
8	Firing pin plate	31	Slide stop spring	60	Lock nut
9	Extractor pin	32	Slide stop	Magazine safety (for magazine catch only, below)	
Sights (specify size!)					
10	Front sight for micrometer sights	33	Safety lever	61	Magazine safety
10a	Front sight for normal sights	34	Magazine catch, side	62	Magazine safety screw
10b	Front sight for contrast sights	35	Magazine catch spring	63	Magazine catch, below
Sights					
11	Normal sights	36	Magazine catch stop	Magazine	
11a	Contrast sights	37	Magazine catch stop spring	64	Box magazine for magazine catch, side
Mikrometer sights					
12	Rear sight base	38	Grip plate left for magazine catch, side	64a	Box magazine for magazine catch, below
13	Rear sight	38a	Grip plate left for magazine catch, below	65	Magazine floorplate for 64
14	Windage correction screw	39	Grip plate, right	65a	Magazine floorplate for 64 a
15	Side spring	40	Grip plate screw	66	Feeder
16	Sight pin	41	Washer	67	Magazine spring
17	Height adjustment screw	42	Grip plate nut	68	Magazine floorplate insert
18	Height spring	43	Grip plate filler		
19	Steel bullet	44	Magazine catch pin		
20	Sight blade	45	Locking screw for action housing		
Front sight base					
21	2 round nuts	46	Threaded pin for trigger stop		
22	2 spacer washers	47	Safety pin for trigger stop		
23	Front sight base	Action			
24	Front sight wedge	48	Action housing		
		49	Trigger bar		
		50	Hammer		

Instruction manual -GB- 34 210 006

12-2004

Subject to technical modifications.